

HDL[®] KNX / EIB

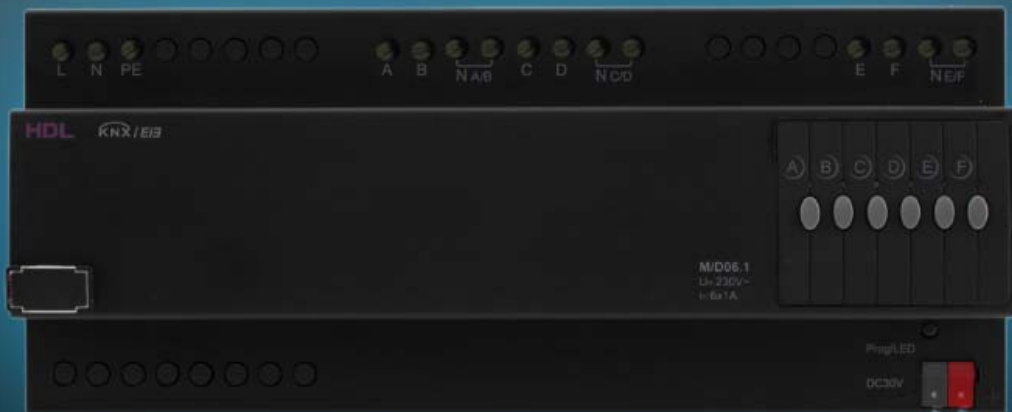

Intelligent edge
trailing dimmer



Guangzhou Hedong Electronic Co.,Ltd(HDL)

HDL KNX / EIB-BUS

(Intelligent Installation Systems)

Product Manual

Contents

1	General.....	4
1.1	Product Function.....	5
2	Hardware	6
2.1	Technical data.....	6
2.2	Dimming mode.....	8
2.2.1	Leading edge dimming mode.....	8
2.2.2	Trailing edge dimming mode.....	8
2.2.3	Change the dimming mode.....	9
2.3	Dimension drawings.....	10
2.4	Wiring diagram.....	10
2.5	Maintenance and Cautions.....	12
3	Software.....	13
3.1	Database functions Overview.....	13
3.2	Object/Association/Group address define.....	14
3.3	Function parameter “General”	15
3.4	Function parameter Channel “N”	18
3.5	A>dimming config.....	24
3.6	A: function.....	25
3.6.1	A: function “staircase light”	26
3.6.2	A: function “flashing”	27
3.6.3	A: function “scene”	29
3.6.4	A: function “threshold”	30
3.6.5	A: function “heating”	32
4	Communication objects description.....	34

4.1	Objects “General”... ..	34
4.2	Objects “Channel N output”	34
4.3	Objects “Response”	35
4.4	Objects “Statistics ON time”	36
4.5	Objects “Temperature”	36
4.6	Objects “Staircase light”	37
4.7	Objects “Flashing”	37
4.8	Objects “Scene”	38
4.9	Objects “Threshold”	39
4.10	Objects “Heating”	39
5	Application.....	41
5.1	Program functions diagram.....	41

1-General

HDL KNX / EIB series dimmer actuator output modules are developed by HDL. Using KNX/EIB BUS communicate with other KNX devices. The database need to be downloaded to the dimmer actuator using ETS2 V1.3 or ETS 3.0, and the document descript how to use these products . Our products use standard according to EMC, electrical safety, environmental conditions.

The dimmer actuators are used to control some loads, such as:

- * **Lighting**
- * **Motor**
- * **Curtain**
- * **Heating**
- * **Other Equipments**

The rights and the copyright to this manual are exclusively the property of HDL.

1.1-Product Function

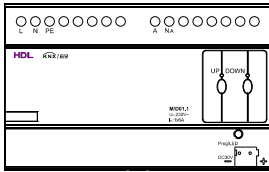

M/D01.1

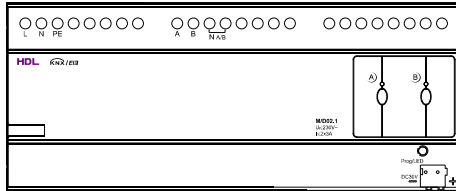

M/D02.1

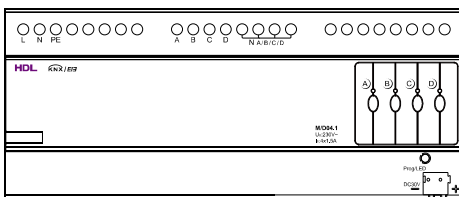

M/D04.1

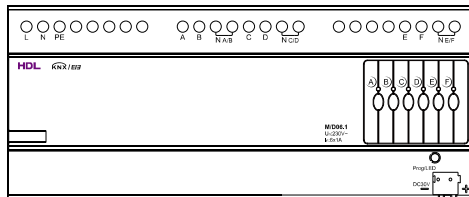

M/D06.1

The Dimmer Actuators can dimming for 1, 2, 4 and 6 channels independent AC loads. The Control parameters is:

*** Each channel output maximum 6A current for Dimmer 1fold Actuator, and can not exceed 6A of total current.

*** Each channel output maximum 3A current for Dimmer 2fold Actuator, and can not exceed 6A of total current.

*** Each channel output maximum 1.5A current for Dimmer 4fold Actuator, and can not exceed 6A of total current.

*** Each channel output maximum 1A current for Dimmer 6fold Actuator, and can not exceed 6A of total current.

The following functions can be set individually for each output channel:

- 1-Statistics total ON time
- 2-Status response
- 3-Status recovery
- 4-Over temperature protection
- 5-Read temperature
- 6-Over temperature alarm
- 7-Staircase light
- 8-Flashing light
- 9-Scene control
- 10-Scene dimming
- 11-Sequence control
- 12-Threshold switch
- 13-Heating actuator(PWM)

2- Hardware

The technical properties of HDL KNX/EIB Dimmer Actuators as the following sections.

2.1 Technical data

Power supply

* Operating voltage (supply by the bus)	21...30 V DC,
* Current consumption EIB / KNX (operate)	< 15 mA
* Current consumption EIB / KNX (standby)	< 5 mA
* Power consumption EIB / KNX (operate)	< 450 mW
* Power consumption EIB / KNX (standby)	< 150 mW

Output nominal values

* Type of Device	M/D01.1	M/D02.1	M/D04.1	M/D06.1
* Number of contacts	1	2	4	6
* In rated current	6 A	3A	1.5A	1A
* Power loss per device at max. load	2.7 W	5.4W	8 W	
* Un rated voltage	250/440V AC (50/60 Hz)			

Output life expectancy

* Mechanical Life	50years
* Electrical Life	20years

Output dimmer actuator without additional DC power

Connections

* EIB / KNX	Bus Connection Terminal 0.8 mm Ø, single core
* Load circuits	Screw terminal with Slotted head 0.2...4 mm ² multi- core 0.4...6 mm ² single-core
* cable shoe	12 mm
* Tightening torque	Max. 0.8 Nm

Operating and display

* Red LED and EIB / KNX program button for assignment of the physical address

Temperature range

* Operation – 5 °C ~ + 45 °C

* Storage	– 25 °C ~ + 55 °C
* Transport	– 25 °C ~ + 70 °C
Environment conditions	
* humidity	max. 95 % Non-condensing
Appearance design	
* Modular	DIN-Rail Modular installation
* Type-M/R	01.1 02.1 04.1 06.1
* Dimensions (H x W x D)	90 x W x 64
* Width W (unit mm)	144 216 216 216
* Mounting width (1P=18 mm)	8P 12P 12P 12P
* Mounting depth (unit mm)	64 64 64 64
Weight (unit kg)	0.26 0.49 0.72
Installation	Use 35 mm mounting rail
Mounting position	Electric dimmer box
Material and Colour	Plastic, Black
Standard and Safety	Certificated
* LVD Standard	EN60669-2-1 , EN60669-1
*EMC Standard	EN50090-2-2
CE mark	
* In accordance with the EMC guideline and low voltage guideline	
Pollutant	Comply with RoHS

Note: All of loads, at 230 V AC

Application table

Type	M/D01. 1	M/D02. 1	M/D04. 1	M/D06. 1
Max. number of communication objects	30	50	90	130
Max. number of group addresses	254	254	254	254
Max. number of associations	254	254	254	254

Note: The programming requires the EIB Software Tools ETS2 V1.3 or ETS3.0. If use ETS2 V1.3, then import "*.vd2". If use ETS3.0, then Import "*.vd3"

2.2 Dimming mode

2.2.1 Trailing edge dimming mode

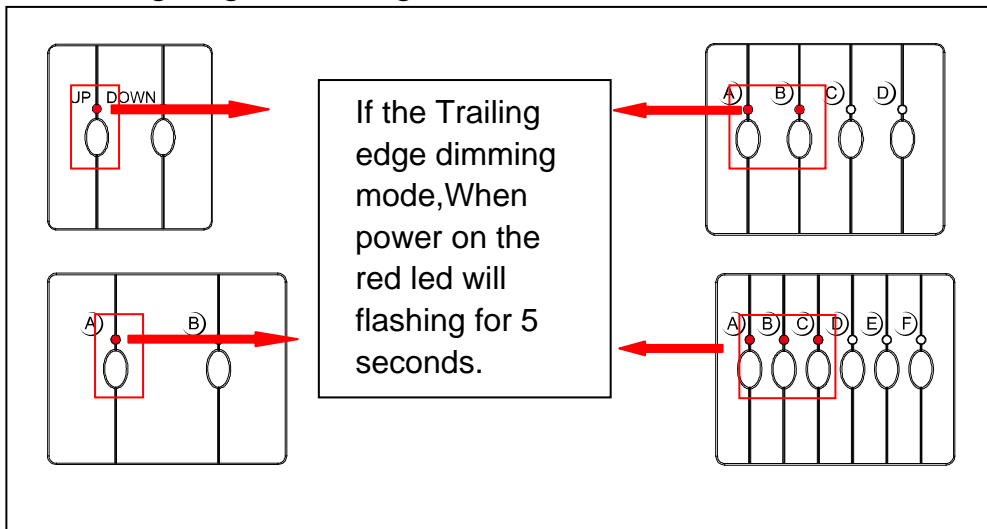

*Note: Resistive or Capacitive load type should use this mode.

For example: Tungsten halogen lamp – mains voltage, Incandescent lamp, Low-Voltage Tungsten halogen lamps with electronic transformers.

2.2.2 Leading edge dimming mode

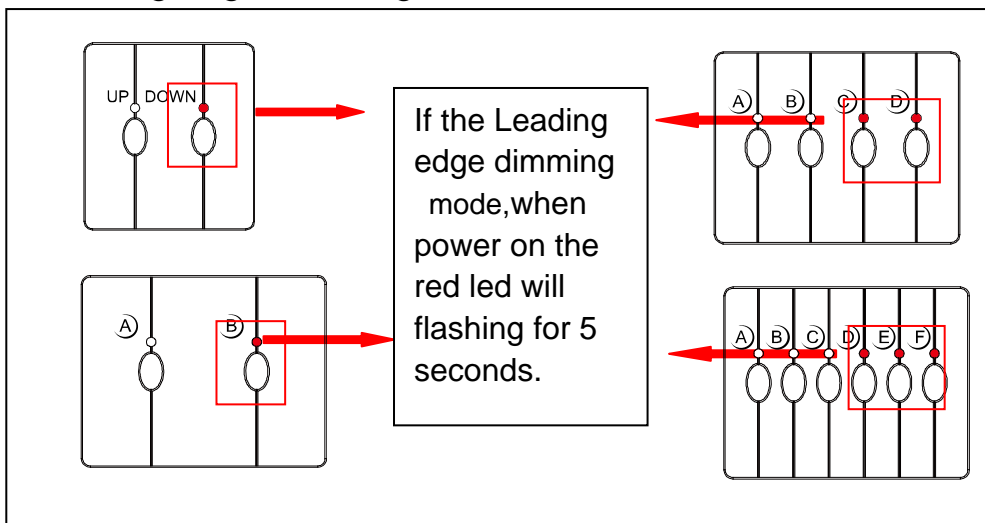

*Note: Inductive or Resistive load type should use this mode.

For example: Tungsten halogen lamp – mains voltage, Incandescent lamp, Low-Voltage Tungsten halogen lamps with conventional transformers, Motors.

2.2.3 Change the dimming mode

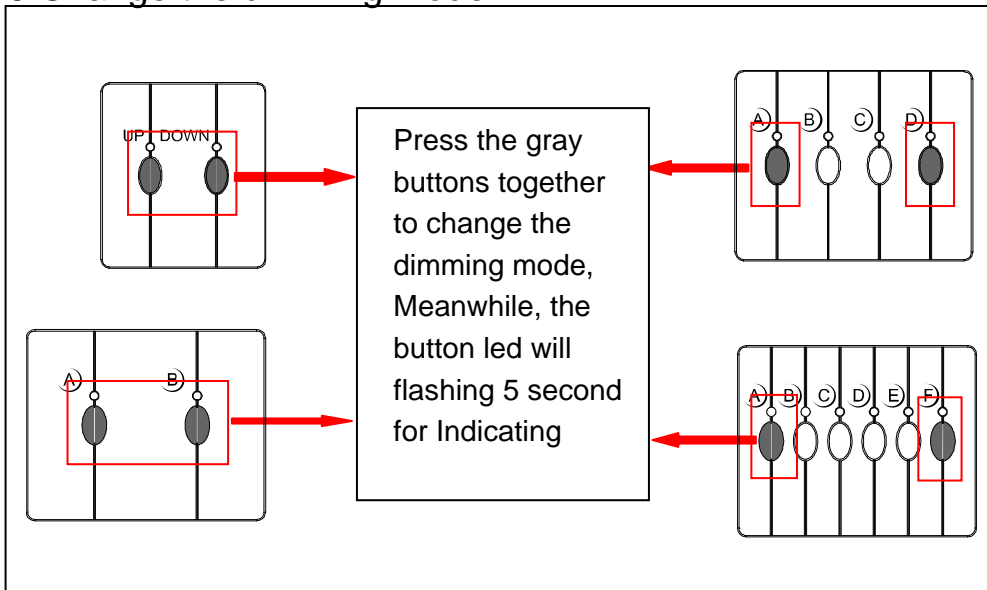

***Note:** Long button press the first button and last button together to change the dimming mode between “Leading edge dimming mode” and “Trailing edge dimming mode”.

For example:MD06.1: press “button A” and “button F” together for change the dimming mode.

2.3 Dimension drawings

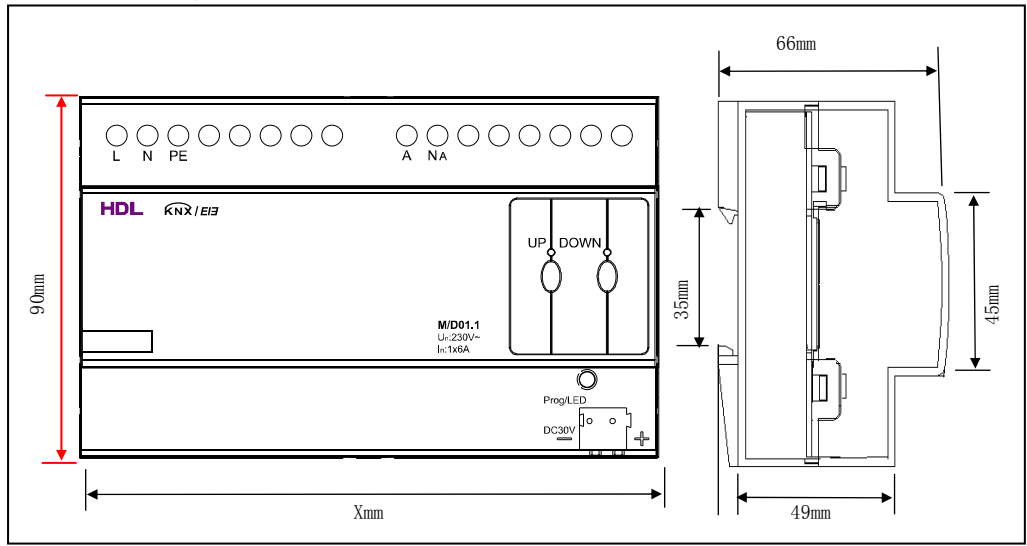

X	M/D01.1 72mm	M/D02.1 216mm	M/D04.1 216mm	M/D06.1 216mm
---	-----------------	------------------	------------------	------------------

2.4 Wiring diagram

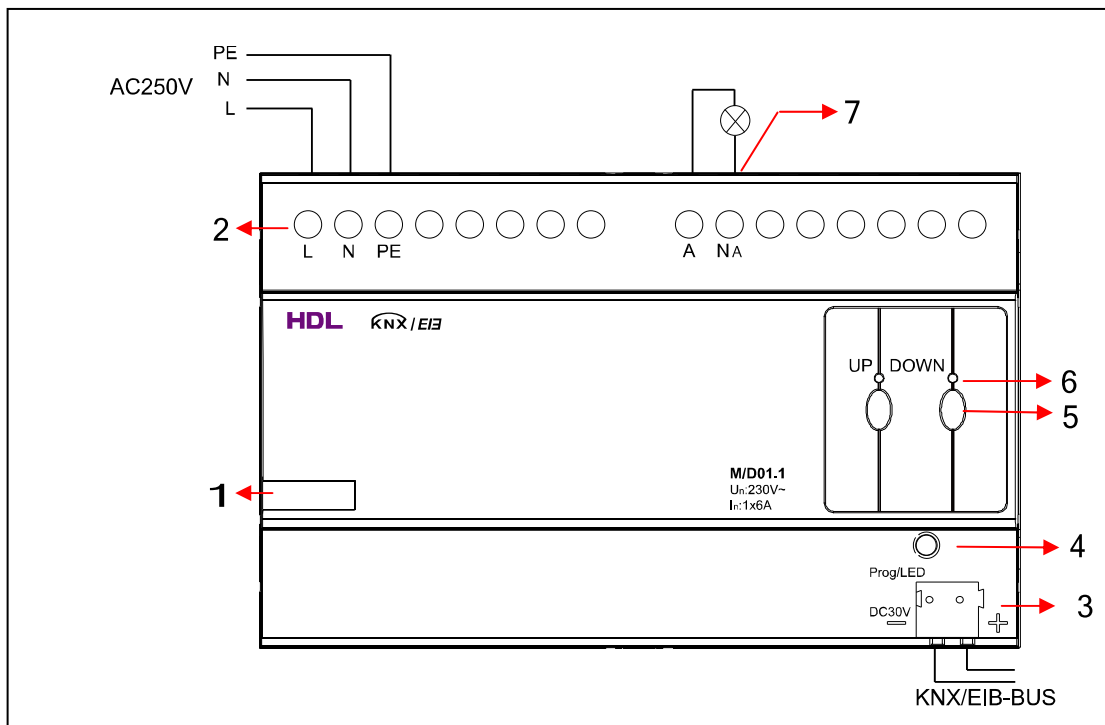

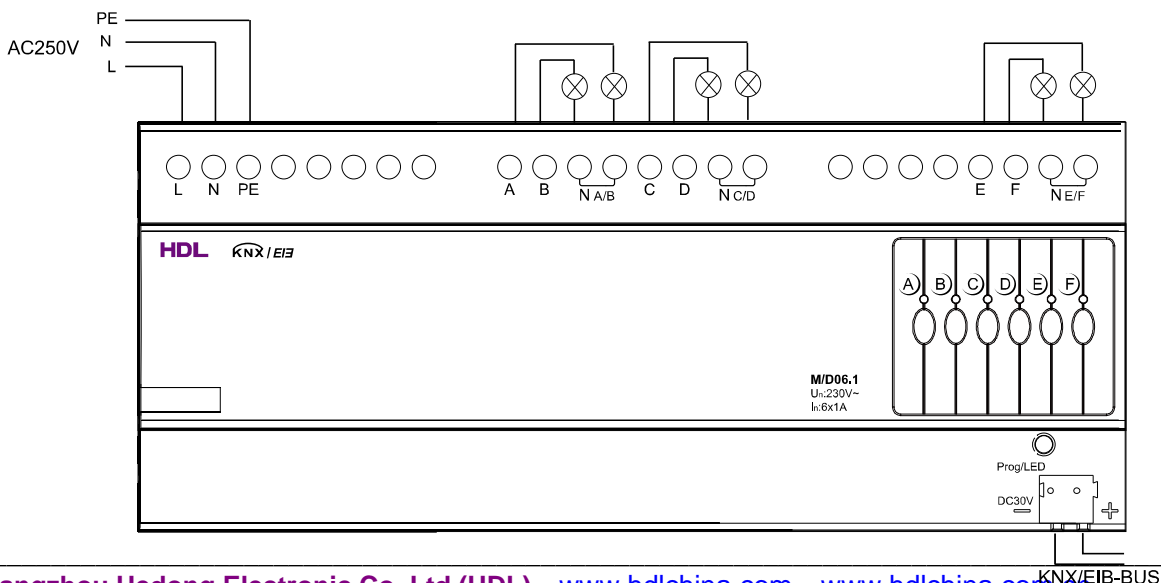
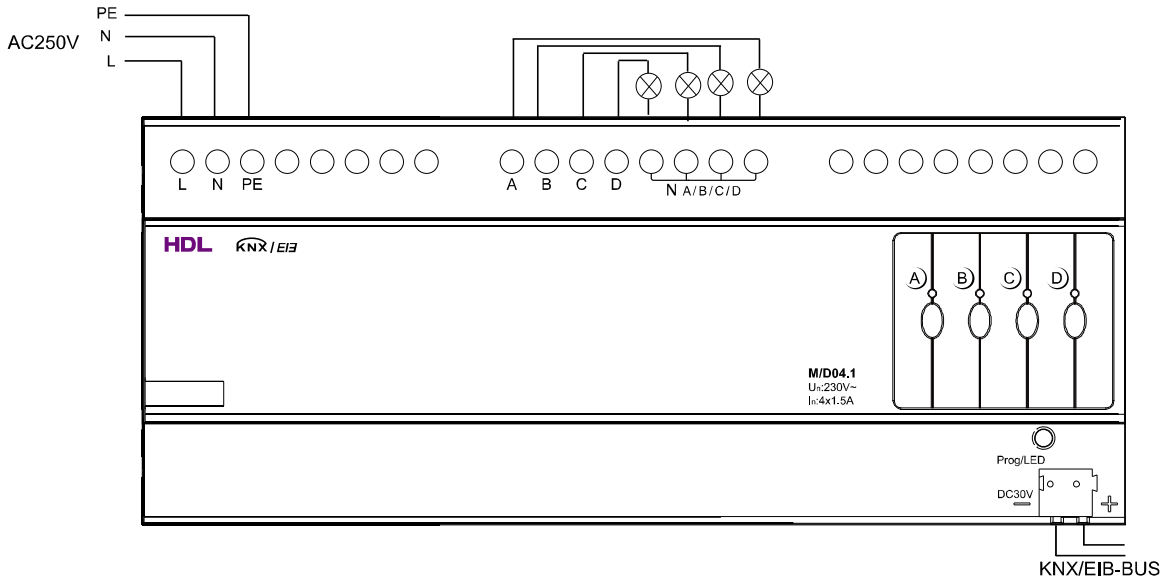
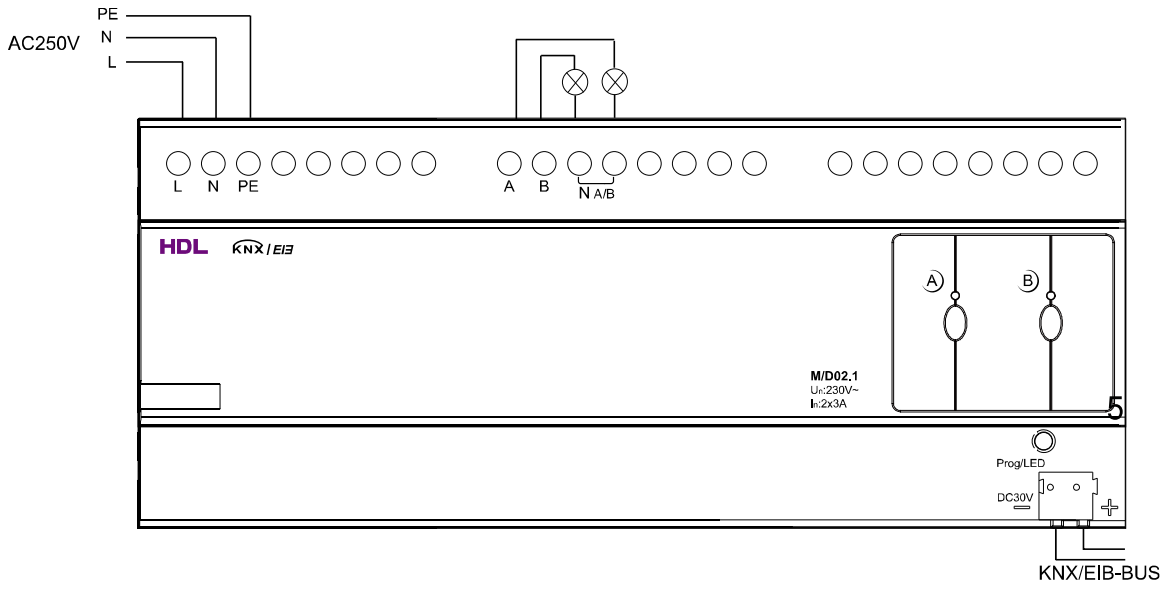

- 1-Label area
- 2-Power input
- 3-KNX/EIB Bus Connector
- 4-Programming button& Programming LED
- 5-Contact position indication and manual operation
- 6-Led state
- 7-Terminal for Load Connection sequence

- Note:**
- a) Dimensions of the space to be provided for each dimmer
 - b) Dimensions and position of the means for supporting and fixing the dimmer within this space
 - c) Minimum clearance between the various parts of the dimmer and the surrounding parts where fitted
 - d) Minimum dimensions of ventilating opening, if needed, and their correct arrangement.
 - e) The protective devices (e.g. fuses, automatic protective devices, etc.) to be connected to the load to avoid overloading

2.5 Maintenance and Cautions

- *Please read this user manual carefully before any operation.
- *Don't close to the interfering devices.
- *The site should be ventilated with good cooling environment.
- *Pay attention to damp proof, quakeproof and dustproof.
- *Avoid rain, other liquids or caustic gas.
- *Please contact professional maintenance staff or HDL service center for repair or fix.
- *Remove the dust regularly and do not wipe the unit with the volatile liquids like alcohol, gasoline, etc.
- *If damaged by damp or liquid, turn off it immediately.
- *Regularly check the circuitry and other related circuit or cables and replace the disqualified circuitry on time.
- *For security, each circuit to connect an MCB or fuse
- *Installation location should be well-ventilated, pay attention to moisture, shock, dust proof.

3- Software

HDL KNX/EIB Dimmer Actuators database use ETS3.0 to do the design. The device types are M/D01.1, M/D012.1, M/D04.1 and M/D06.1, and the databases name are “Dimmer 1fold Actuator”, “Dimmer 2fold Actuator”, “Dimmer 4fold Actuator”, “Dimmer 6fold Actuator”. All Interface and the functions Apply parameters please overview the following description of the paragraph.

Each channel output of the Dimmer Actuators are independent and the same. So, Understand only one channel output is enough. The following paragraph will description of the first channel output in detail.

3.1 Database functions Overview

The following table provide an overview of the functions and some parameters with the switch actuators:

Switch function	M/D01. 1	M/D02. 1	M/D04. 1	M/D06. 1
General	---	---	---	---
Cycle telegram (heartbeat)	Y	Y	Y	Y
System delay after recovery	Y	Y	Y	Y
Sequence	Y	Y	Y	Y
Channel	---	---	---	---
Statistics total ON time	Y	Y	Y	Y
Voltage Recovery state	Y	Y	Y	Y
Over temperature protection	Y	Y	Y	Y
Read temperature	Y	Y	Y	Y
Dimming	---	---	---	---
Switch ON/OFF	Y	Y	Y	Y
Relative dimming	Y	Y	Y	Y
Absolutre dimming	Y	Y	Y	Y
function	---	---	---	---
Staircase light	---	---	---	---
	Y	Y	Y	Y
Flashing	---	---	---	---
	Y	Y	Y	Y
Scene	Y	Y	Y	Y

SceneNO.1-64	Y	Y	Y	Y
Threshold	---	---	---	---
Threshold lower	Y	Y	Y	Y
Threshold middle	Y	Y	Y	Y
Threshold upper	Y	Y	Y	Y
Heating Actuator	---	---	---	---
PWM	Y	Y	Y	Y

Table1: Database application overview.

3.2 Object/Association/Group address define

In following table, The objects is assigned to the some function of the channel output pages, If active some functions and the object will be valid. One or more group addresses can be assigned to a object. The association will connect group addresses to the object.

Name	type	Max. number of communication objects	Max. number of associations	Max .number of group addresses
Dimmer 1fold Actuator	M/D01.1	30	254	254
Dimmer 2fold Actuator	M/D02.1	50	254	254
Dimmer 4fold Actuator	M/D04.1	90	254	254
Dimmer 6fold Actuator	M/D06.1	130	254	254

Table2: Overview the max. number of the objects, max. number of associations and max. number of the group addresses

Note: If you use ETS2V1.3, Please import “VD2”, But you use the ETS3.0, Please Import “VD3” to “VD3”.

3.3 Function parameter “General”

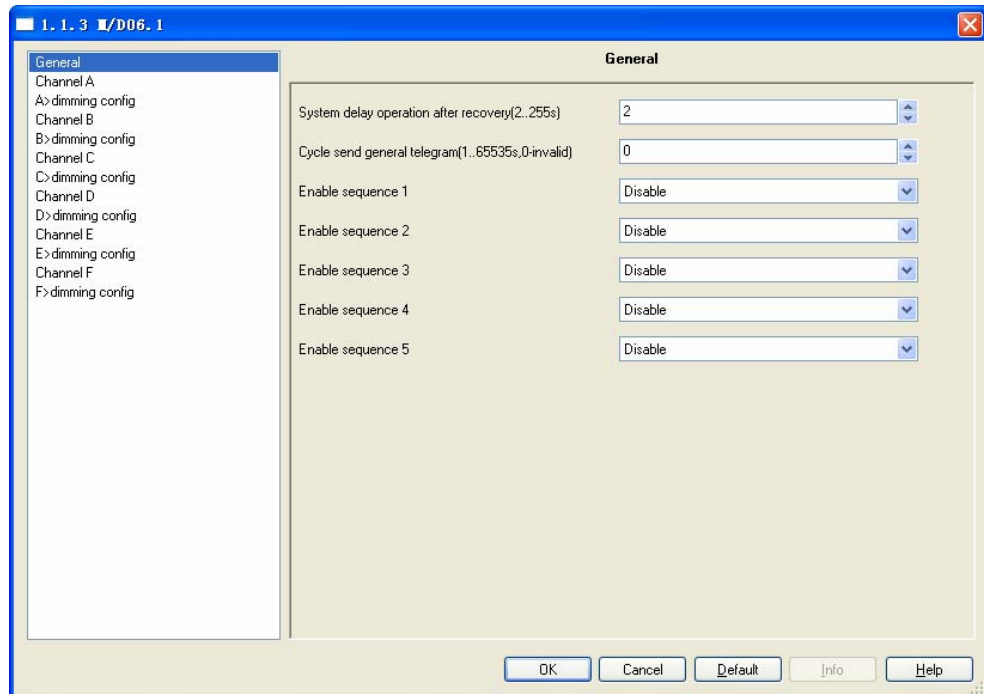

Fig1: “General” parameter window

“In the parameter of the general windows can set 7 parameters “System delay after recovery”, “Cycle send general telegram and Enable sequence1-5”.

---System delay after recovery(2..255s)

Can operate relay for a delay time 2..255s after the power on. The default value is 2 seconds. The Min. value is 2 seconds, and the max. value is 255 seconds.

Options: **2...255s**

When the power on and the timer start.when time out, The dimming can be allowed to operating . This function is selected by user

---Cycle send general telegram(1..65535s,0-invalid)

The range of the parameter is 0 to 65535s. Zero of parameter disable the function , other of parameter enable this function

Options: 0...65535s

The parameter set to nonzero, Device will send a telegram data cyclically when time out. Send the value alternately between 0 and 1.

---Enable sequence 1

Set the enable of the sequence.

Options: Disable
Enable

Disable: Disable the sequence function

Enable: Enable the sequence function, Set as follows

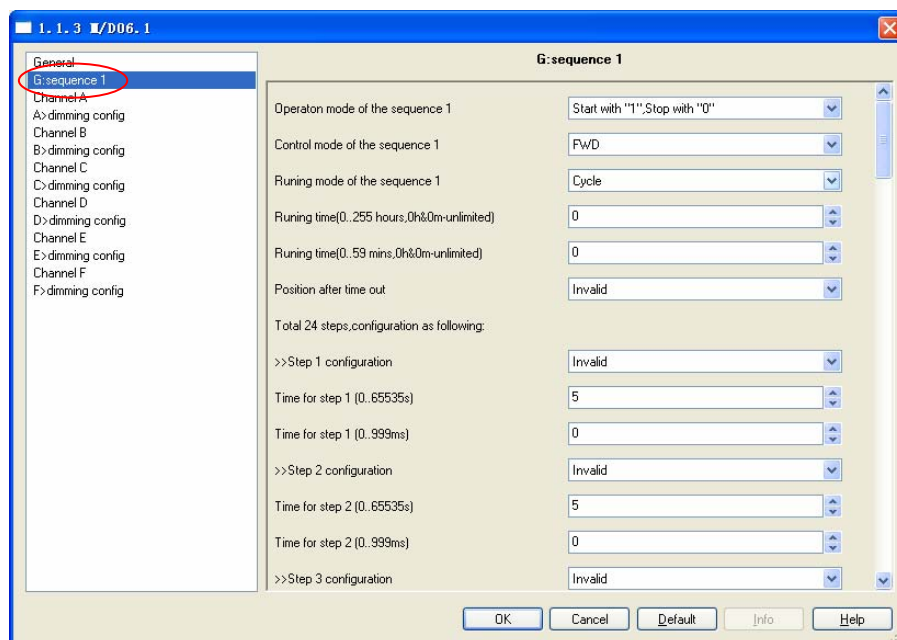

Fig:1.1 “G: sequence 1” parameter window

It includes 24 steps.

---Operation mode of the sequence 1

Set the operation mode.

Options: Start with “1”,Stop with “0”
Start with “0”,Stop with “1”
Start with “1/0”,can’t stop

Start with “1”,Stop with “0”: When receives “1”, then run sequence 1,When receives 0, then stop sequence 1.

Start with “0”, Stop with “1”: when receives 0, then sequence 1, When receives 1, then stop sequence 1.

Start with “1/0”,can’t stop: Both receive 1 or 0,.start the sequence 1.

---Control mode of the sequence 1

Set the control mode.

Options: FWD

REW

Random

FWD: Forward mode

REW: Back work mode

RANDOM: Random mode

---Running mode of the sequence 1

Set the running mode

Options: Single

Cycle

Single: Run only ones.

Cycle: Cycle run.

---Running time(0...255hours,0h&0m-unlimited)

Set the sequence running time .

Options: 0-255

---Running time(0...59mins, 0h&0m-unlimited)

Set the sequence running time. The longest time is 59mins.

Options: 0-59

Note:Unlimited when the time set to 0h&0m.

---Position after time out

If the sequence running in Cycle mode,and is run time greater than zero,After time out,the sequence will back to this set position.

Total 24steps, configuration as following:

---Step 1 configuration

Options: invalid

Scene NO.01

...

Scene NO.64

---Time for step 1(0...65535s)

Set the time for the step. The longest time is 65535s.

---Time for step 1(0...999ms)

Set the time for the step. The longest time is 999ms.

Set of other steps is same as the step 1.

3.4 Function parameter Channel “N”

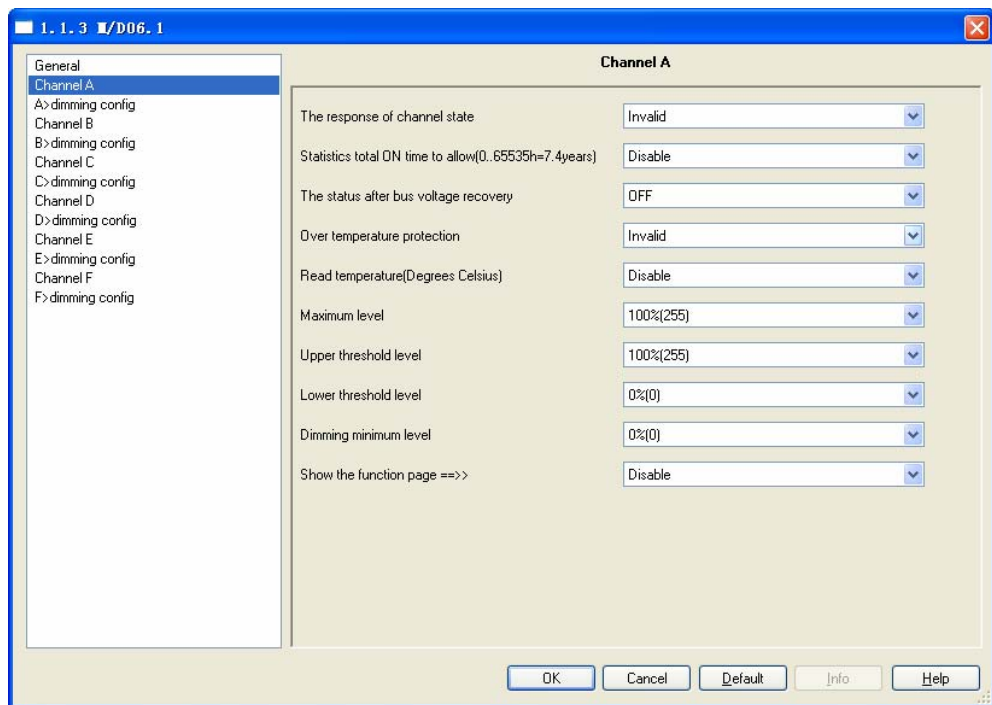

Fig2: “Channel N” parameter(N=A,B,C...) windows

In the parameter windows of the “Channel N”, you can set some common functions. Through functional selection and download the database to the device, and device will work in accordance with the selected function.

---The response of channel state

If the dimmer was controlled will be response.

Options: **Invalid**

1 bit always response

1 bit only changed

1 byte always response

1 byte only changed

1 bit always response: it always response,

If the channel is ON, then response 1

If the dimmer is OFF, response 0

1 bit only changed: it will be response when the dimmer state was changed

1 byte always response: it always response of the light level value.

1 byte only changed: it will be response when the light value was changed.

---Statistics total ON time to allow(0...65535h=7.4years)

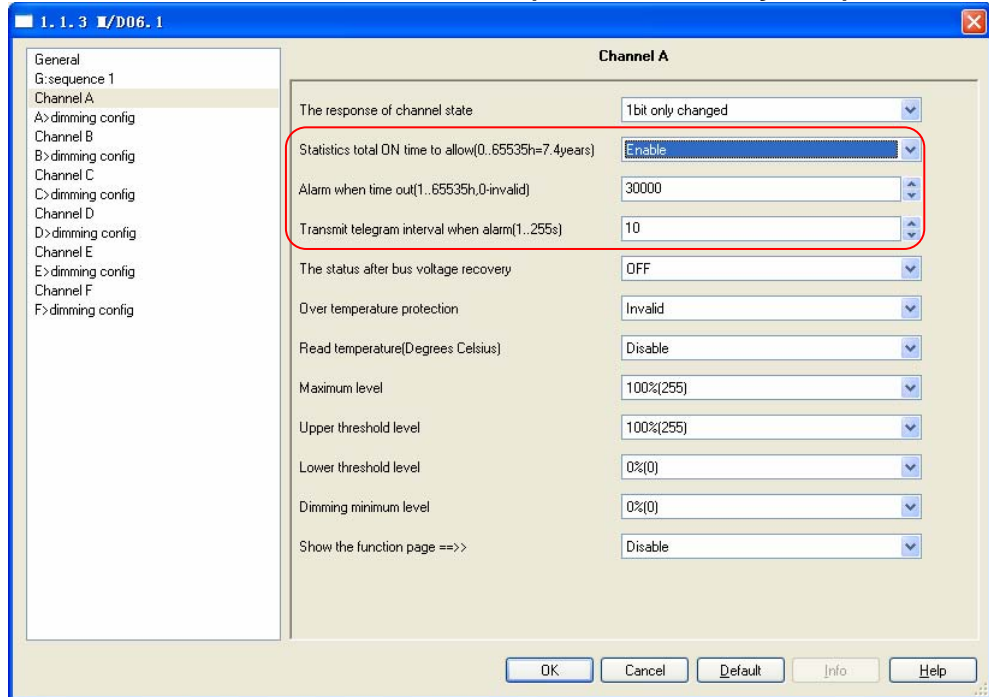

Fig2.1: “Statistics total ON time to allow”

This function is used to calculate the total ON time for channel output, The maximum time is 65535h. This function is very useful, Because can know channel work status through this function.

Options: Disable

Enable

Disable: don't timing.

Enable: Statistics time.

- **Alarm when time out (1...65535h,0-invalid)**

When the device's operating time arrive the setting value will alarm.

The value rang is 1...65535h, 0 is invalid.

- **Transmit telegram interval when alarm**

Set the alarm time interval.

---The status after bus voltage recovery

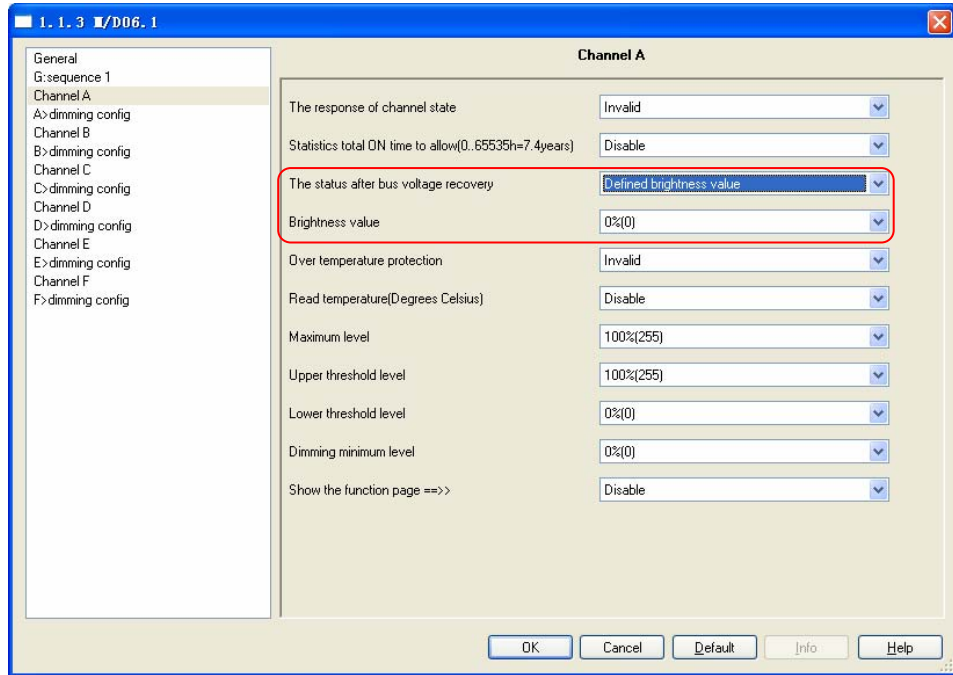

Fig2.2: “The status after bus voltage recovery ”

Set the status of restore mode after power on for each channel.

Options: Off

- Defined brightness value
- Last brightness value

Off:After power on and the channel’s status is off.

Defined brightness value: After power on and the channel’s status is defined brightness value

Last brightness value: After power on and the channel’s status is last brightness value

---Over temperature protection

Set the mode of the channel when over temperature.

Options: Invalid

- Alarm
- Off
- Reduce power

Invalid: no the function.

Alarm: When over temperature will alarm.

OFF: When over temperature will OFF

Reduce: When over temperature will Reduce power.

Alarm: When over temperature will alarm.

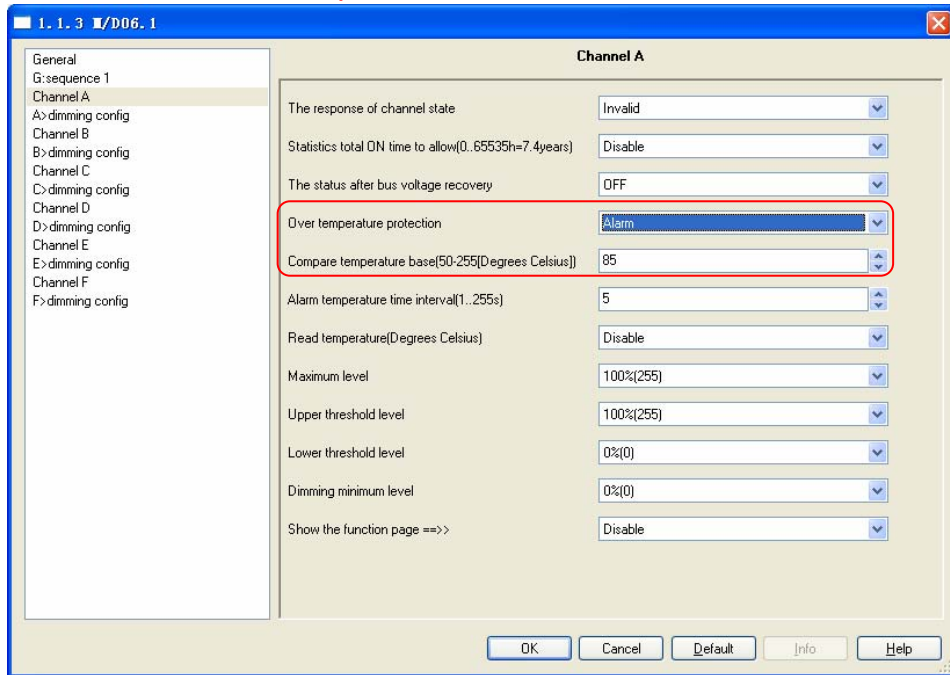

Fig2.3: “Over temperature protection”

- Compare temperature protection
Set the standard temperature. when the temperature over the standard and this channel will be protection. The range is 70-90.
- Alarm temperature time interval
The alarm telegram time interval range is 1-255.

Off: When over temperature will off.

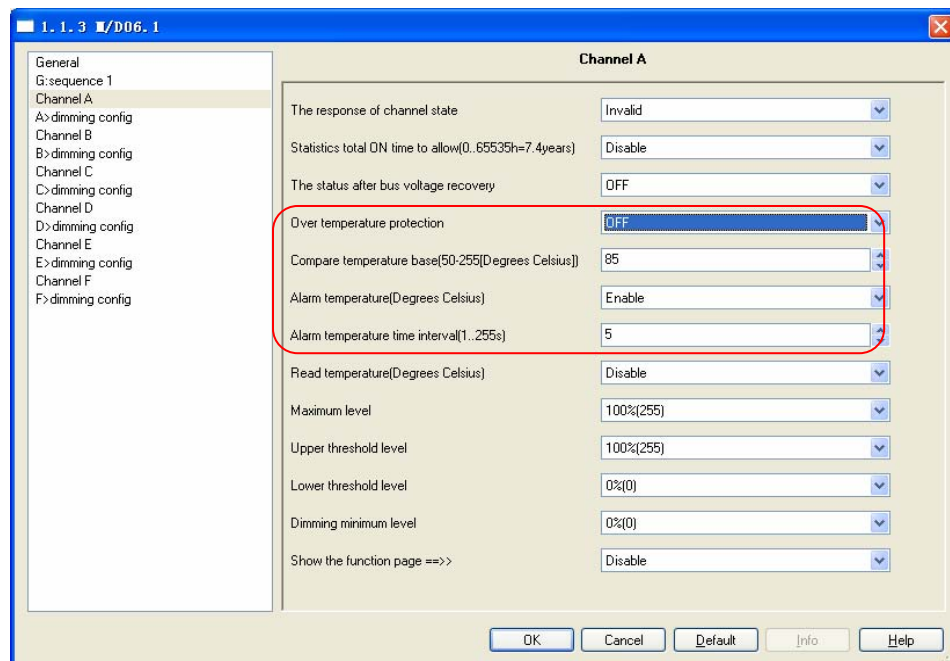
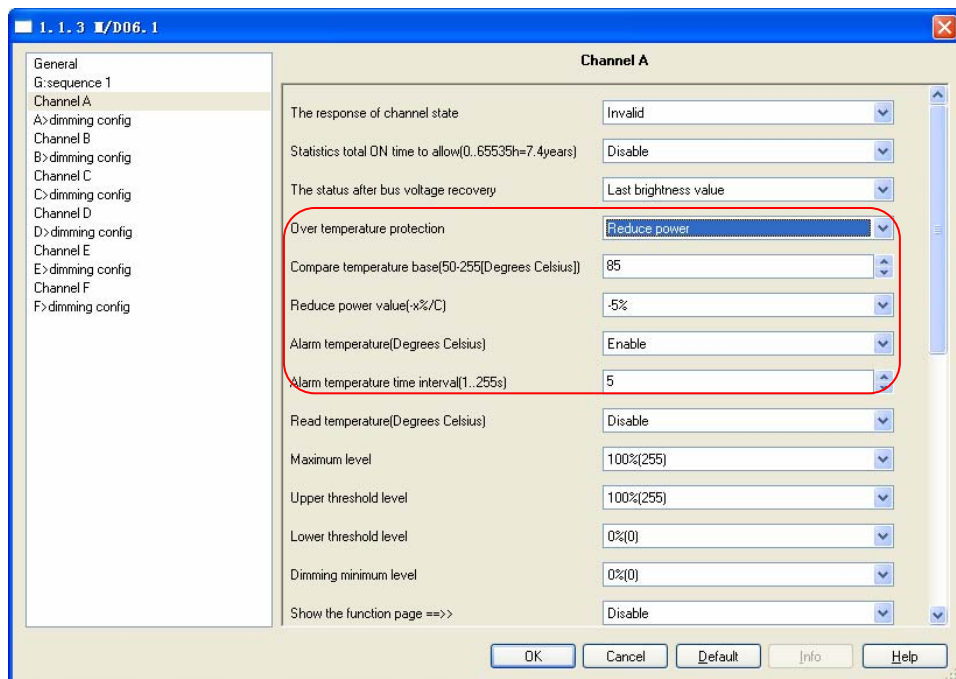

Fig2.3: “Over temperature protection”

- Compare temperature protection
Set the standard temperature, the devices will be off when the temperature over the standard. The range is 70-90.
- Alarm temperature(Degrees Celsius)
Set the standard temperature, when the temperature over the standard will be alarm.
- Alarm temperature time interval(1...255s)
The time interval range is 1-255.

Reduce power: When over temperature will reduce power.

**Fig2.4: “Over temperature protection”**

- Compare temperature base[70-90(Degrees Celsius)]
Set the standard temperature, the devices will be reduce power when the temperature over the standard. The range is 70-90.
- Reduce power value(-x%/5C)
Set the standard temperature, when the temperature over the standard will be alarm.
- Alarm temperature (Degrees Celsius)
Set the standard temperature, when the temperature over the standard will be alarm.
- Alarm temperature time interval(1...255s)
The time interval range is 1-255.

---Read temperature (Degrees Celsius)

Set the enable to read temperature.

Options: Disable
Enable

Disable: No allow to read temperature

Enable: Allow to read temperature

---Maximum level

Set the maximum level.

Options: 0%(0)-100%(255)

---Upper threshold level

Set the upper threshold level.

Options: 0%(0)-100%(255)

---Lower threshold level

Set the lower threshold level.

Options: 0%(0)-100%(255)

---Dimming minimum level

Set the dimming minimum level.

Options: 0%(0)-100%(255)

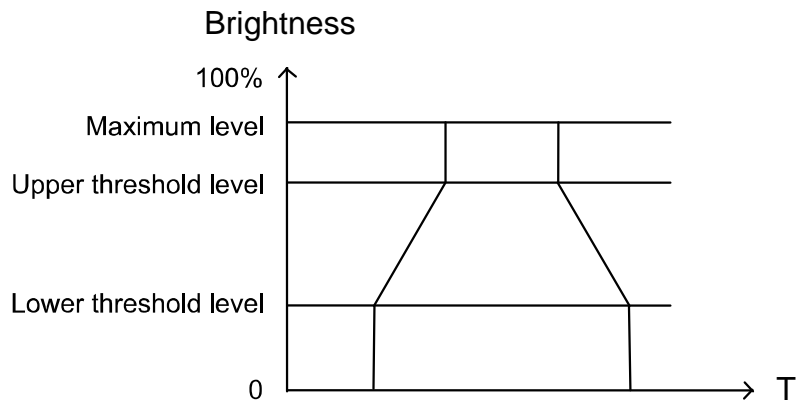
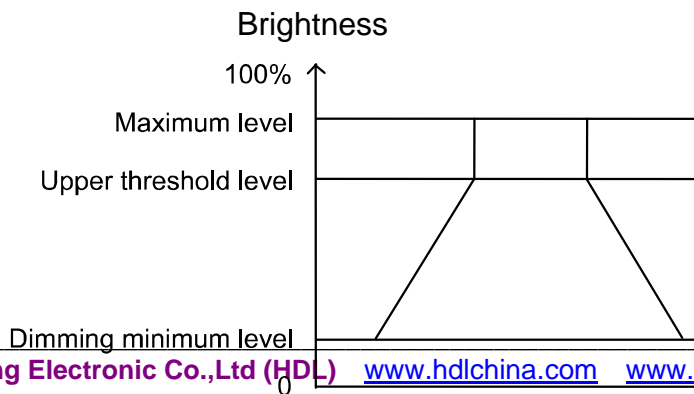

Fig 2.5 Switch ON/OFF or Absolute dimming



T

Fig 2.6 Relative dimming

---Show the function page

Set the enable and show the function page.

Options: Disable
Enable

Disable: Don't show the function page about dimmer.

Enable: Show the function page, the page is set the function about dimmer.

3.5 A>dimming config

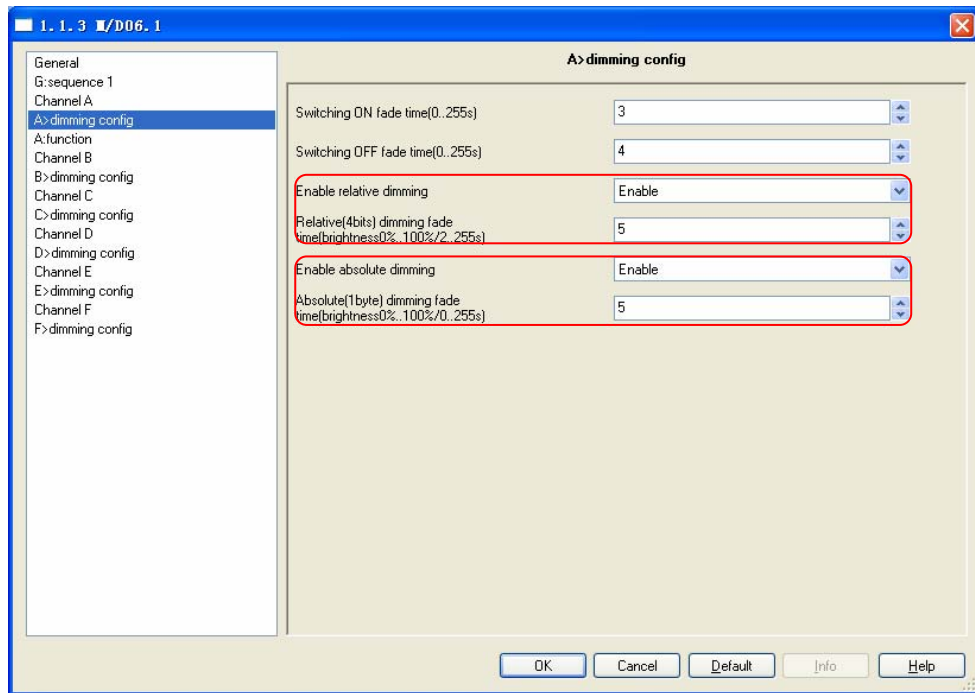

Fig3: A>dimming config

---Switching ON fade time(0...255s)

Set the time for switch ON.

Note: brightness0%...100%/0..255s

---Switching OFF fade time(0...255s)

Set the time for switch OFF.

Note: brightness0%...100%/0..255s

---Enable relative dimming

Options: Disable
Enable

Disable: No allow to relative dimming

Enable: Allow to relative dimming

Note:Relative dimming fade time(brightness0%...100%/0..255s),the data length is 4bits

---Enable absolute dimming

Options: Disable

Enable

Disable: No allow to absolute dimming

Enable: Allow to absolute dimming

Note:Ablolute dimming fade time(brightness0%...100%/0..255s),the data length is 1byte

3.6 A: function

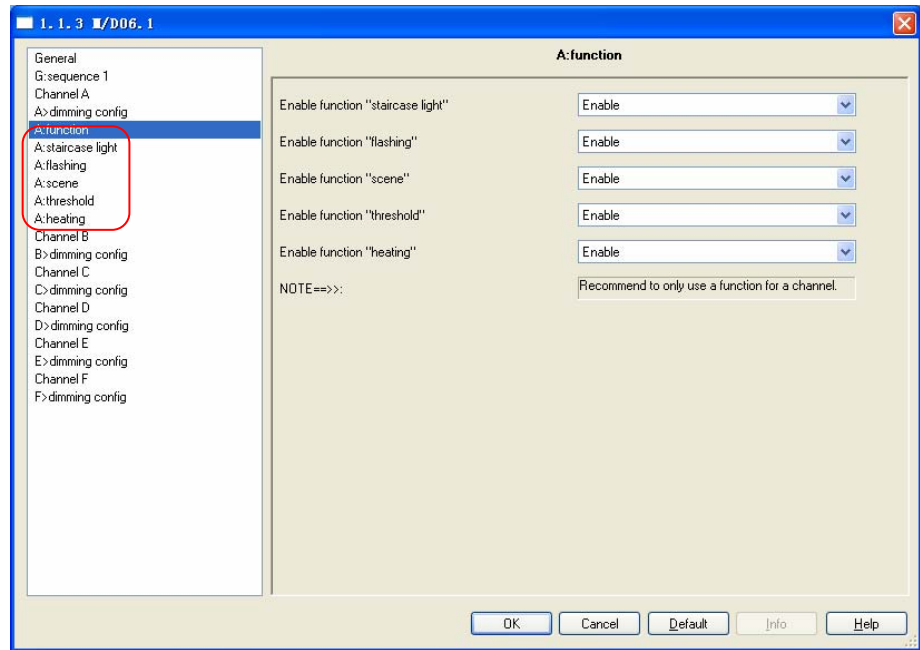

Fig4: Function window

The window is set the enable for the below function.

---Enable function “staircase light”

---Enable function “flashing”

---Enable function “scene”

---Enable function “threshold”

---Enable function “heating”

3.6.1 A: function “staircase light”

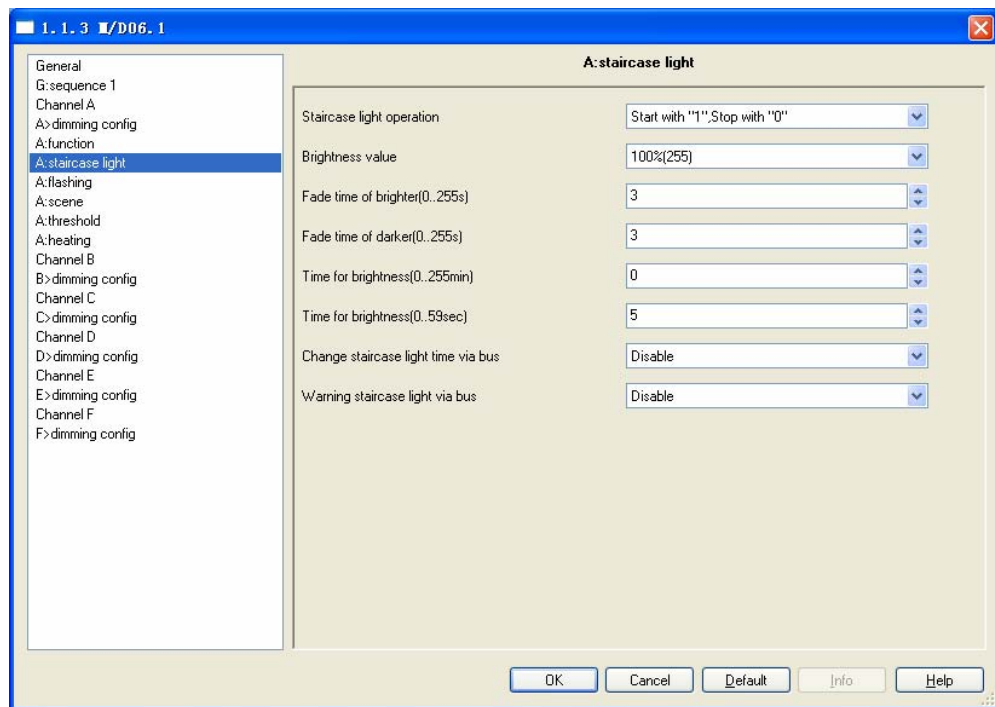

Fig4.1: “staircases light” window

For staircase application

---Staircase lighting operation

- Options:** Start with “1”, stop with“0”
 Start with“1”, invalid with“0”
 Start with“1/0”,can’t stop

Start with “1”, stop with“0”: When receive data 1 and the staircase light start run automatic, stop with time out or stop with 0.

Start with“1”, invalid with“0”: When receive data 1 and the staircase light start run automatic, 0 is invalid.

Start with“1/0”, can’t stop: When receive data 1/0 and the staircase light start run automatic, Can’t stop.

---Brightness value

Set the brightness value of staircase light.

---Fade time of brighter: (0...255s)

Fade seconds in the brighter state.

--- Fade time of darker: (0...255s)

Fade seconds in the darker state.

---Duration time for brightness: (0...255 Min)

Duration minutes in the brightness state.

---Duration time for brightness: (0...59 Sec)

Duration seconds in the brightness state

---Change staircase lighting time via bus

Options: **Disable**
Enable

Disable: Can't modify staircase lighting delay off time via bus , only can be set by database.

Enable: allow modify staircase lighting delay off time via bus by user.

---Warning staircase lighting

Options: **Disable**
Enable

Disable: Prohibition Alarm.

Enable: Allow send out warning state use warning data point for ON/OFF staircase light.

3.6.2 A: function “flashing”

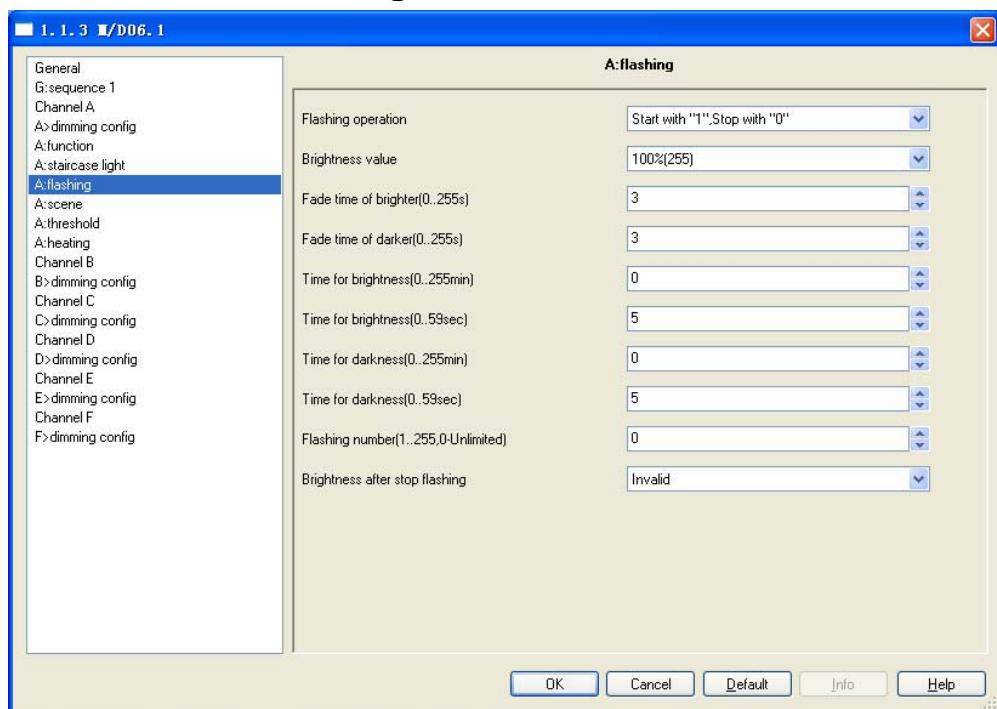

Fig4.2: “flashing” window

Flashing between ON and OFF in this mode.

---Flashing operation

Three Control modes for this function.

Options: Start with “1”, stop with“0”

Start with“1”, invalid with“0”

Start with“1/0”,can’t stop

Start with “1”, stop with“0” Start flashing with 1 and stop flashing with 0.

Start with“1”, invalid with“0”: Start flashing with 1 and invalid with 0.

Start with“1/0”,can’t stop: Start flashing with 1 or 0,can’t stop.

---Fade time of brighter: (0...255s)

Fade seconds in the brighter state.

--- Fade time of darker: (0...255s)

Fade seconds in the darker state.

--- Duration time for brightness: (0...255 Min)

Duration minutes in the brightness state.

---Duration time for brightness: (0...59 Sec)

Duration seconds in the brightness state

---Duration time for darkness: (0...255 Min)

Duration minutes in the darkness state.

---Duration time for darkness: (0...59 Sec)

Duration seconds in the darkness state

---Flashing number (0...255, 0-Unlimited)

The number of flashing, range between 0 and 255. 0 is unlimited.

---Brightness after stop flashing

Brightness after stop flashing by overflow counter, the range is 0%(0)...100% (255).

3.6.3 A: function “scene”

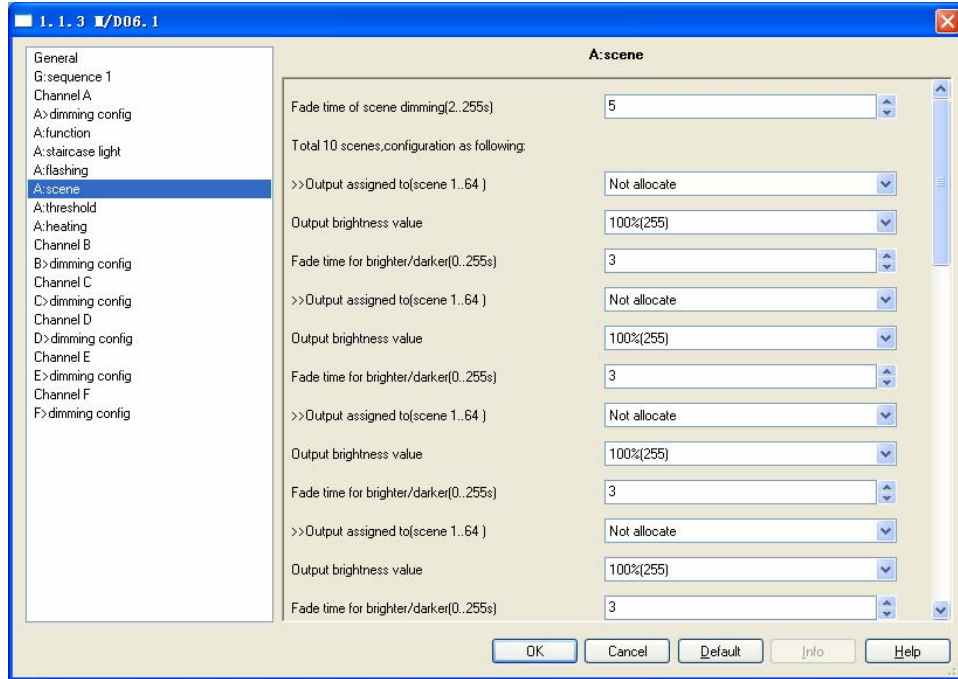

Fig4.3: “scene” window

---Fade time of scene dimming: (0...255s)
 Fade seconds in the brighter state.

Total 10 scenes, configuration as following, the setting like below.

Each scene is same as following:

--->>Output assigned to(scene 1..64)

Allocate the scene.

---Output brightness value

Set the output brightness value 0%..100%

---Fade time for brighter/darker (0...255s)

Set the time for brighter or darker.

3.6.4 A: function “threshold”

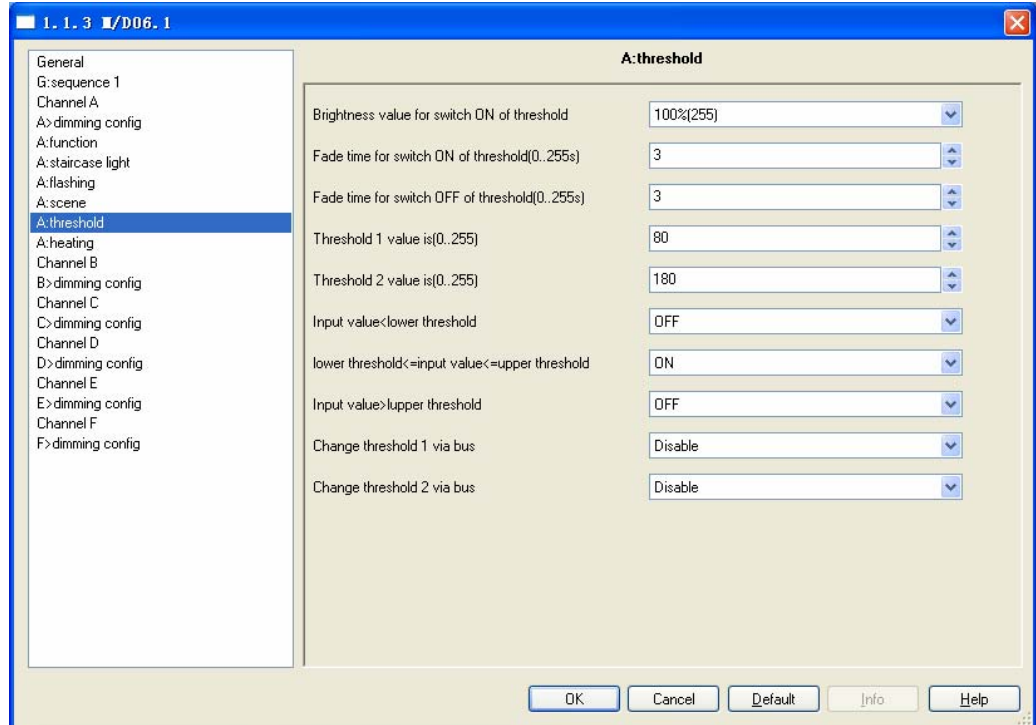

Fig4.4: “threshold” window

---Brightness value for switch ON of threshold

Config the brightness for the switch ON

---Fade time for switch ON of threshold (0...255s)

Config the time for switch ON

---Fade time for switch OFF of threshold (0...255s)

Config the time for switch OFF

---Threshold 1 value is (0...255)

Set threshold 1 value between 0 and 255. Default is 80.

---Threshold 2 value is (0...255)

Set threshold 2 value between 0 and 255. Default is 180.

---Input value<Lower threshold

If the value of receiving telegram from bus lower than the minimum

threshold value, the switch will action according to below option (ON or OFF or no Unchange)

Options: **Unchange**

ON

OFF

Unchange: The channel switch position no changed.

ON: The channel switch position set to ON.

OFF: The channel switch position set to OFF

---Lower threshold<=Input value<=Upper threshold

If the value of receiving telegram from bus between Lower threshold and Upper threshold, the switch will action according to below option (ON or OFF or no action)

Options: **Unchange**

ON

OFF

Unchange: The channel switch position no changed.

ON: The channel switch position set to ON.

OFF: The channel switch position set to OFF

---Input value>Upper threshold

If the value of receiving telegram from bus more than the upper threshold value, the switch will action according to below option (ON or OFF or no action)

Options: **Unchange**

ON

OFF

Unchange: The channel switch position no changed.

ON: The channel switch position set to ON.

OFF: The channel switch position set to OFF

---Change threshold 1 via bus

Options: **Disable**

Enable

Disable:No allow to change the threshold 1 value from bus.

Enable:Allow to change the threshold 1 value from bus.

---Change threshold 2 via bus

Options: **Disable**
Enable

Disable:No allow to change the threshold 2 value from bus.

Enable:Allow to change the threshold 2 value from bus.

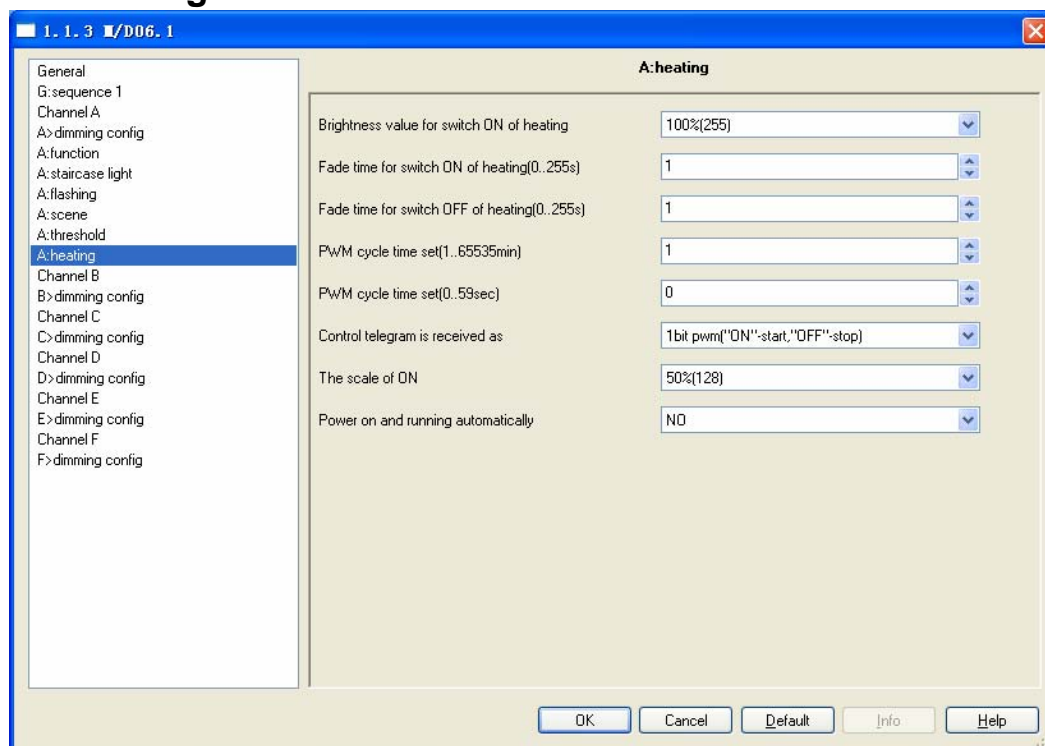
3.6.5 A: function “heating”**Fig4.5: “heating” window****---Brightness value for switch ON of heating**

Config the brightness for the switch ON

---Fade time for switch ON of heating (0...255s)

Config the time for switch ON

---Fade time for switch OFF of heating (0...255s)

Config the time for switch OFF

---PWM cycle time set(1...65535min)

Options:1...65535m

This cycle time is set Minimum is 1 minutes

---PWM cycle time set(1...59sec)

Options:**0..59s**

This cycle time is set in seconds

---Control telegram is received as

Type of control can be control as 1bit or 1byte.

Options: **1bit PWM(1-start/0-stop)**

1byte(255-switch ON/0-switch OFF/ other valve)

1bit PWM(1-start/0-stop): The PWM start and switch ON by the value of receiving telegram “1” , and stop by “0”.

1byte(255-ON/0-OFF/other valve): the switch ON always by the value of receiving telegram “255”, the switch OFF by the value of receiving telegram “0”. The PWM runs and pulse width of PWM is set according to the value of receiving telegram (1 to 254)

---The scale of ON

This parameter will set the valve of the PWM (pulse width).

Options: **0%(OFF)**

10%(26)

20%(51)

30%(77)

40%(102)

50%(128)

60%(153)

70%(179)

80%(204)

90%(230)

100%(ON)

---Power on and running automatically

The PWM runs automatic by the setting YES, The PWM runs by manual when set to NO.

Options: **NO**

YES

YES: PWM running automatic at power on.

NO: PWM running by manual.

4-Communication objects description

Note: In following sections the N=A,B,C...

4.1 Objects “General”

Number	Name	Object Function	Descript...	Group Add...	Length	C	R	W	T	U
0	General	Send cycles			1 bit	C	R	-	T	-
1	General	Sequence 1			1 bit	C	-	W	-	U
2	General	Sequence 2			1 bit	C	-	W	-	U
3	General	Sequence 3			1 bit	C	-	W	-	U
4	General	Sequence 4			1 bit	C	-	W	-	U
5	General	Sequence 5			1 bit	C	-	W	-	U

NO.	Object name	Function	Flags	Data type
0	General	Send cycles	C R T	DPT 1.003 1bit
This communication object is always active and valid. invert the value send telegram to bus in next frame. e.g. last telegram value is “1”, the next telegram value is “0”				
1..5	General	Sequence1..5	C W U	DPT 1.010 1bit
These communication object used to start or stop sequence. Send telegram value “1” for start one sequence, Send telegram value “0” for stop one sequence.				

4.2 Objects “Channel N output”

Number	Name	Object Function	Descript...	Group Add...	Length	C	R	W	T	U
0	General	Send cycles			1 bit	C	R	-	T	-
10	Output A	Channel output			1 bit	C	-	W	-	U
11	Output A	Relative dimming(4bit)			4 bit	C	-	W	-	U
12	Output A	Absolute dimming(8bit)			1 Byte	C	-	W	-	U
30	Output B	Channel output			1 bit	C	-	W	-	U
31	Output B	Relative dimming(4bit)			4 bit	C	-	W	-	U
32	Output B	Absolute dimming(8bit)			1 Byte	C	-	W	-	U
50	Output C	Channel output			1 bit	C	-	W	-	U
51	Output C	Relative dimming(4bit)			4 bit	C	-	W	-	U
52	Output C	Absolute dimming(8bit)			1 Byte	C	-	W	-	U
70	Output D	Channel output			1 bit	C	-	W	-	U
71	Output D	Relative dimming(4bit)			4 bit	C	-	W	-	U
72	Output D	Absolute dimming(8bit)			1 Byte	C	-	W	-	U
90	Output E	Channel output			1 bit	C	-	W	-	U
91	Output E	Relative dimming(4bit)			4 bit	C	-	W	-	U
92	Output E	Absolute dimming(8bit)			1 Byte	C	-	W	-	U
110	Output F	Channel output			1 bit	C	-	W	-	U
111	Output F	Relative dimming(4bit)			4 bit	C	-	W	-	U
112	Output F	Absolute dimming(8bit)			1 Byte	C	-	W	-	U

NO.	Object name	Function	Flags	Data type
10	Output N	Channel putput	C W U	DPT 1.001 1bit
This communication objects of the channel output used for ON/OFF an channel output, the dimmer channel output ON when the object receive the value is “1”. The dimmer channel output OFF when the object receive the value is “0”				
11	Output N	Relative dimming	C W U	DPT 3.007 4bit
This communication objects of the channel output used for relative diming an channel output. Relative dimming mode is UP or DOWN.Dimming UP when receive the telegram increase value,and dimming DOWN when receive the telegram decrease value.				
12	Output N	Absolute dimming	C W U	DPT 5.001 1byte
This communication objects of the channel output used for absolute diming an channel output. The channel output absolute dimming to a brightness according to receive a telegram value.				
.....				

4.3 Objects “Response”

Number	Name	Object Function	Descript...	Group Add...	Length	C	R	W	T	U
0	General	Send cycles			1 bit	C	R	-	T	-
10	Output A	Channel output			1 bit	C	-	W	-	U
13	Output A	Response state			1 bit	C	R	-	T	-

Response 1bit status

Number	Name	Object Function	Descript...	Group Add...	Length	C	R	W	T	U
0	General	Send cycles			1 bit	C	R	-	T	-
10	Output A	Channel output			1 bit	C	-	W	-	U
14	Output A	Response state			1 Byte	C	R	-	T	-

Response 1byte status

NO.	Object name	Function	Flags	Data type
13	Output N	Response status	C R T	DPT 1.001 1bit
This communication object used response the channel ouput N state, channel state is ON the response state is “1”, Otherwise the state is “0”				
14	Output N	Response status	C W U	DPT 5.001 1byte
This communication object used response the channel ouput N brightness.				
.....				

4.4 Objects “Statistics ON time”

Number	Name	Object Function	Descript...	Group Add...	Length	C	R	W	T	U
0	General	Send cycles			1 bit	C	R	-	T	-
10	Output A	Channel output			1 bit	C	-	W	-	U
15	Output A	R/W total ON time			2 Byte	C	R	W	T	U
16	Output A	Alarm when total ON time out			1 bit	C	R	-	T	-

NO.	Object name	Function	Flags	Data type
15	Output N	R/W total ON time	C R W T U	DPT 7.007 2byte
This communication object used to change the initial value. Statistical ON time and increase again every hour.				
16	Output N	Alarm when total ON time out	C R T	DPT 1.005 1bit
This communication object used to alarm when statistical ON time reach a set maximum value.				
.....				

4.5 Objects “Temperature”

Number	Name	Object Function	Descript...	Group Add...	Length	C	R	W	T	U
0	General	Send cycles			1 bit	C	R	-	T	-
10	Output A	Channel output			1 bit	C	-	W	-	U
17	Output A	Temperature alarm			1 bit	C	R	-	T	-
18	Output A	Read temperature			2 Byte	C	R	-	T	-

NO.	Object name	Function	Flags	Data type
-----	-------------	----------	-------	-----------

17	Output N	Temperature alarm	C W U	DPT 1.005 1bit
This communication object used to alarm when over temperature.				
18	Output N	Read temperature	C R T	DPT 9.001 2byte
This communication object used to read the channel output temperature.				
.....				

4.6 Objects “Staircase light”

Number	Name	Object Function	Descript...	Group Add...	Length	C	R	W	T	U
0	General	Send cycles			1 bit	C	R	-	T	-
10	Output A	Channel output			1 bit	C	-	W	-	U
19	Output A	Staircase light			1 bit	C	-	W	-	U
20	Output A	Change staircase light time			2 Byte	C	-	W	-	U
21	Output A	Warning staircase light			1 bit	C	R	-	T	-

NO.	Object name	Function	Flags	Data type
19	Output N	Staircase light	C W U	DPT 1.001 1bit
This communication object used to start or stop the staircase light function. Start the staircase light when receive the telegram value “1”.				
20	Output N	Change staircase light time	C W U	DPT 7.005 2byte
This communication object used to change the staircase light time.				
21	Output N	Warning staircase light	C R T	DPT 1.005 1bit
This communication object used to warning the staircase light.				
.....				

4.7 Objects “Flashing”

Number	Name	Object Function	Descript...	Group Add...	Length	C	R	W	T	U
0	General	Send cycles			1 bit	C	R	-	T	-
10	Output A	Channel output			1 bit	C	-	W	-	U
22	Output A	Flashing			1 bit	C	-	W	-	U

NO.	Object name	Function	Flags	Data type
22	Output N	Flashing	C W U	DPT 1.001 1bit
This communication object used to flashing of channel light.The channel light flashing when receive the start value.				
.....				

4.8 Objects “Scene”

Number	Name	Object Function	Descript...	Group Add...	Length	C	R	W	T	U
0	General	Send cycles			1 bit	C	R	-	T	-
10	Output A	Channel output			1 bit	C	-	W	-	U
23	Output A	Scene(8bit)			1 Byte	C	-	W	-	U
24	Output A	Scene dimming(4bit)			4 bit	C	-	W	-	U

NO.	Object name	Function	Flags	Data type								
23	Output N	Scene(8bit)	C W U	DPT 18.001 1byte								
This communication object used to call or save the scene of channel output												
The scene control see following explain:												
Telegram value: <table border="1" style="display: inline-table; vertical-align: middle;"> <tr> <td>C</td><td>R</td><td>N</td><td>N</td><td>N</td><td>N</td><td>N</td><td>N</td> </tr> </table>					C	R	N	N	N	N	N	N
C	R	N	N	N	N	N	N					
C: 0-Call scene 1-Store scene(If scene allocated and the scene is the current switch state)												
R: Reserved												
N: Scen NO.(bin:000000...111111=NO.1...64)												
e.g: Hexadecimal												

00h-----call scene 1 (If scene allocated) 01h-----call scene 2 (If scene allocated) 3Fh-----call scene 64 (If scene allocated) 80h-----store scene 1 (If scene allocated) 81h-----store scene 2 (If scene allocated) BFh-----store scene 64 (If scene allocated)				
24	Output N	Scene dimming(4bit)	C W U	DPT 3.007 4bit
This communication object used to dimming the scene of channel ouput				
.....				

4.9 Objects “Threshold”

Number	Name	Object Function	Descript...	Group Add...	Length	C	R	W	T	U
0	General	Send cycles			1 bit	C	R	-	T	-
10	Output A	Channel output			1 bit	C	-	W	-	U
25	Output A	Threshold input			1 Byte	C	-	W	-	U
26	Output A	Change threshold 1			1 Byte	C	-	W	-	U
27	Output A	Change threshold 2			1 Byte	C	-	W	-	U

NO.	Object name	Function	Flags	Data type
25	Output N	Threshold input	C W U	DPT 5.004 1byte
If this communication object is activity , the input value of receiving telegram from bus compare with threshold 1 and threshold 2 calculate the state of switch according to the setting of database.				
26	Output N	Change threshold 1	C W U	DPT 5.004 1byte t
Change threshold1 value via bus.				
27	Output N	Change threshold 2	C W U	DPT 5.004 1byte
Change threshold2 value via bus.				
.....				

4.10 Objects “Heating”

Number	Name	Object Function	Descript...	Group Add...	Length	C	R	W	T	U
0	General	Send cycles			1 bit	C	R	-	T	-
10	Output A	Channel output			1 bit	C	-	W	-	U
28	Output A	Heat with 1bit control			1 bit	C	-	W	-	U

1 bit heating control

Number	Name	Object Function	Descript...	Group Add...	Length	C	R	W	T	U
0	General	Send cycles			1 bit	C	R	-	T	-
10	Output A	Channel output			1 bit	C	-	W	-	U
28	Output A	Heat with 1byte control			1 Byte	C	-	W	-	U

1 byte heating control

NO.	Object name	Function	Flags	Data type
28	Output N	Heat with 1bit control	C W U	DPT1.001 1bit
If work in heating actuator, this communication object default show and valid. Start PWM by receive telegram "1", stop PWM by receive telegram "0", start running automatic when power on set by ETS				
28	Output N	Heat with 1byte control	C W U	DPT 5.004 1byte
If select "heat with byte control", this communication object has been showed and valid. Can modify value of PWM by receive 1byte data. output ON always if receive value is 255, output OFF if receive value is 0, otherwise output PWM according to the value of receiving telegram from bus.				
.....				

5-Application

5.1 Program functions diagram

